



SPARE PARTS FOR
COMMERCIAL VEHICLES

'21

UNIVERSAL



NOTE: All previous editions are no longer valid after new published catalogue.

Products sold by AUGER are not original parts but they are interchangeable with them and they are sold under our brand.

All original equipment manufacturers (OEM) numbers, symbols and descriptions are used for identifications purpose only. They will not be used in delivery notes or invoice to our customers.

We cannot accept any responsibility for errors which may occur from the printing etc. This catalogue is not permitted to be reprinted or duplicated even partially without our prior written permission.

We reserve the right to make technical changes and design modifications.

The information provided in this catalogue has been researched and prepared with utmost care. However specifications, descriptions and illustrative material contained herein are subject to possible changes without notice. We do not accept liability for any errors in this issue.

AUGER frequently updates and improves its products. AUGER may discontinue to offer or modify its products at any time. Please consult your AUGER country representative for specific product information.

The brand AUGER® is a registered and protected trademark.
Registration numbers are; CTM 14965834, M 2014 00939, DE 302014055048

Explanation of the used terms in this catalogue;

Replaces: The spare part which shown is a product of AUGER® brand, it can be used instead of the original spare part of the vehicle manufacturer.

Replaces No with "S" letter: The spare part which shown is differs from the original spare part or repair kit but it is still interchangeable with them. Please pay attention product descriptions or ask your country representative for these differences.

Suitable for: The spare part which shown is suitable for the listed vehicles, models, product types etc.

Thank you for choosing AUGER products.

UNIVERSAL

Article Groups

TACHOGRAPH DISC SET / FIRE TUBE BOX	1
BATTERY	1 - 2
COUPLING	3 - 4
AIR CLEANING COIL / AIR COIL	4 - 5
CABLE	6
SOCKET / PLUG	7
BALL JOINT	8
FLEXIBLE HOSES	8
CLAMPS	9
WINDSCREEN WIPER	10
FUEL TANK ACCESSORY	11
FUEL TRANSFER PUMP / FUEL TANK	12 - 13
SCR SYSTEM	13
MUDGUARD	14 - 15
WEDGE / WEDGE CLAMP	15
NUT INDICATOR	16 - 20
STUD CAP	20
LANDING GEAR	21 - 22
SPRING REPAIR KIT / LASHING STRAP	22 - 23
BUFFER	24 - 25
LIGHTINGS / REFLECTOR	26 - 38
BULBS	39 - 44
FITTINGS	45 - 72

Independent Aftermarket Company

FOR EUROPEAN COMMERCIAL VEHICLES

iamauger.com



Auger No. Properties

Auger No. Properties



79648 Tachograph Disc Set,
Central Electric Unit
125 km/h



82795 Fire Tube Box, Accessory

Plastic,
Capacity 6 Kg

Auger No.

Properties

79182

Master Switch, Battery



12/24V, 200-500 A

79185

Master Switch, Battery



12/24V, 200 A

79186

Master Switch, Battery



12/24V, 200 A

79187

Master Switch, Battery



12/24V, 200 A

79188

Master Switch, Battery



12/24V, 200 A

Auger No.

Properties

79189

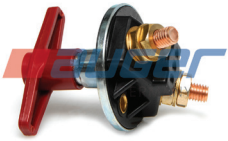

Master Switch, Battery

12/24V, 200 A

79190



Master Switch, Battery

12/24V, 200-500 A

86676



Battery Terminal, Battery

Positive Pole

86677



Battery Terminal, Battery

Negative Pole

68398

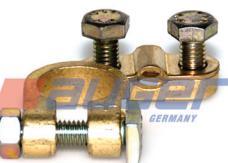

Battery Terminal, Battery

Positive Pole

68399



Battery Terminal, Battery

Negative Pole

Hydraulic Pump

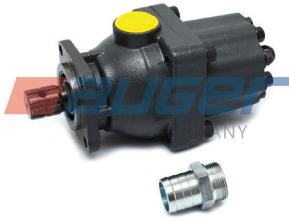
Auger No.
75182
Properties

Service With Dumping Platform

Dimensions

80 Lt

Trailer Axle Lifting Valve



Type-1

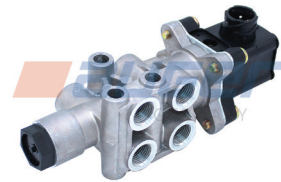

Type-2

Auger No.
107498
Properties

24 V

Type

1

97434

24 V, Bayonet

2

Trailer Axle Lifting Valve (For Control)



Type-1



Type-2



Type-3



Type-4

Auger No.
107500
Properties

Joystick Type

Type

1

107501

With Double Buttons

2

107502

With Tripple Buttons

3

107503

With Quadruple Buttons

4

Axle Lifting Winding Set



Type-1



Type-2



Type-3

Auger No.	Properties	Type
107504	24 V	1
107505	12 V	2
107506	24 V	2
107507	24 V	3

Dump and Axle Winding Set



Type-1



Type-2



Type-3



Type-4

Auger No.	Properties	Type
107508	12 V, Singel	1
107509	24 V, Single	1
107510	12 V, Double	2
107511	24 V, Double	2
107512	G18", 24 V, Doeble	2
107513	12 V, Tripple	3
107514	24 V, Tripple	3
107515	24 V, Quadruple	4
107516	12 V, Quadruple	4

Valve

Auger No.
Properties
Dimensions
107517

Air Spring

1/4" - 3x2

107518

Air

1/4" - 3x2

107519

Air Spring

1/4" - 5x2

107520

Air

1/4" - 5x2

107521

Pull

1/4" - 3x2

107522

Pull Spring

1/4" - 3x2

107523

Push Spring

1/4" - 3x2

107524

Pull

1/4" - 5x2

107525

Pull Spring

1/4" - 5x2

107526

Push Spring

1/4" - 5x2

Coupling



Auger No.

Description

Dimensions

52513

Automatic, For Emergency, Red,
Max. Operating Pres.: 8 Bar

Port Threads: M22x1,5

52514

Automatic, For Emergency, Red,
Max. Operating Pres.: 10 Bar

Port Threads: M16x1,5

52517

Standard, For Emergency, Red,
Max. Operating Pres.: 8 Bar

Port Threads: M22x1,5

52518

Standard, For Emergency, Red,
Max. Operating Pres.: 10 Bar

Port Threads: M16x1,5



52515

Automatic, For Brake, Yellow,
Max. Operating Pres.: 8 Bar

Port Threads: M22x1,5

52516

Automatic, For Brake, Yellow,
Max. Operating Pres.: 10 Bar

Port Threads: M16x1,5

52519

Standard, For Brake, Yellow,
Max. Operating Pres.: 8 Bar

Port Threads: M22x1,5

52520

Standard, For Brake, Yellow,
Max. Operating Pres.: 10 Bar

Port Threads: M16x1,5



54687

With Integrated Filter, Red,
Semitrailer

M16x1,5

54688

With Integrated Filter, Red,
Drawbar Trailer

M16x1,5

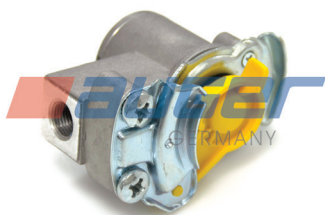

54689

With Integrated Filter, Yellow,
Semitrailer

M16x1,5

54690

With Integrated Filter, Yellow,
with Nut , Drawbar Trailer

M16x1,5

54691

With Integrated Filter, Yellow,
with Test Connector, Semitrailer

M16x1,5

54692

With Integrated Filter, Yellow,
with Test Connector and Nut,
Drawbar Trailer

M16x1,5

Handle Grip, Coupling



Auger No.	Description
54767	M16

Seal Ring, Coupling

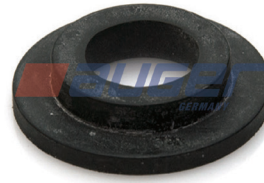

Auger No.	Description
52590	ø19xø28,5/ø41,5x8,5

Air Cleaning Coil



Type-1



Type-2



Type-3



Type-4

Auger No.	Description	Dimensions	Type
55411	Red, PUR	Metal Air Gun	1
68295	Red, PUR	Plastic Air Gun	2
55412	Yellow, PUR	Metal Air Gun	3
68296	Yellow, PUR	Plastic Air Gun	4

Air Coil



Auger No.

Description

Dimensions

54751	Yellow, PA	M16x1,5 - M16x1,5
80194	Yellow, PU	M16x1,5 - M16x1,5
87111	Yellow, PA	M16x1,5 - M18x1,5
54753	Yellow, PA	M22x1,5 - M22x1,5
80196	Yellow, PU	M22x1,5 - M22x1,5



54752	Red, PA	M16x1,5 - M16x1,5
80195	Red, PU	M16x1,5 - M16x1,5
87113	Red, PA	M16x1,5 - M18x1,5
54754	Red, PA	M22x1,5 - M22x1,5
80197	Red, PU	M22x1,5 - M22x1,5



54764	Black/Yellow, PA	M16x1,5 - M16x1,5
80203	Black/Yellow, PU	M16x1,5 - M16x1,5
54766	Black/Yellow, PA	M22x1,5 - M22x1,5
80205	Black/Yellow, PU	M22x1,5 - M22x1,5
87112	Black/Yellow, PA	M18x1,5 F - M16x1,5
108637	Black/Yellow, PA	M18x1,5 F - M18x1,5 F



54763	Black/Red, PA	M16x1,5 - M16x1,5
80202	Black/Red, PU	M16x1,5 - M16x1,5
54765	Black/Red, PA	M22x1,5 - M22x1,5
80204	Black/Red, PU	M22x1,5 - M22x1,5
87312	Black/Red, PA	M18x1,5 F - M16x1,5
108636	Black/Red, PA	M18x1,5 F - M18x1,5 F

Electrical Cable, Trailer Electrical Equipments



Auger No.	Description	L (m)
55413	N Type Black Aluminium Plugs, 24V, Black Cable, Pu	4,5



Auger No.	Description	L (m)
55415	S Type White Aluminium Plugs, 24V, Black Cable, Pu	4,5

ABS Cable



Auger No.	Description	L (m)
54736	With 2 Abs Plugs, 5 Pole, Pu, 24V	3,5
54738	With 2 Abs Plugs, 5 Pole, Pu, 24V	4,5



Auger No.	Description	L (m)
54744	With 2 ADR Plugs, 15 Pole, Pu, 24V	3,5
54746	With 2 ADR Plugs, 15 Pole, Pu, 24V	4,5

EBS Cable



Auger No.	Description	L (m)
54740	With 2 Ebs Plugs, 7 Pole, Pu, 24V	3,5
54742	With 2 Ebs Plugs, 7 Pole, Pu, 24V	4,5

Adapter Cable, Trailer Electrical Equipments



Type-1



Type-2

Auger No.	Description	L (m)	Type
87352	With Socket Type S/N, 15 Pole, Pu	3	1
87263	With Socket Type S/N, 15 Pole, Pu	3,5	1
54748	With Socket Type S/N, 15 Pole, Pu	3,5	2
54750	With Socket Type S/N, 15 Pole, Pu	4,5	2

Socket



Type-1



Type-2



Type-3



Type-4

Type-5

Auger No.	Description	Type
52592	7 Pole Aluminium, 24V, S Type Screw	1
54724	7 Pole Plastic, 24V, S Type Screw, Black	1
97916	7 Pole, 24V, S Type Screw	1
52522	7 Pole Aluminium, 24V, N Type Screw	2
54723	7 Pole Plastic, 24V, N Type Screw, Black	2
54725	Abs, 5 Pole	3
54727	Abs, 15 Pole	3
54726	Ebs, 7 Pole	4
97898	7 Pole, 24V, N Type Screw	5

Plug



Type-1



Type-2



Type-3



Type-4

Auger No.	Description	Type
52591	7 Pole Aluminium, 24V, S Type Screw, White	1
54716	7 Pole Plastic, 24V, S Type Screw, White	1
52521	7 Pole Aluminium, 24V, N Type Screw, Black	2
54715	7 Pole Plastic, 24V, N Type Screw, Black	2
54717	Abs, 5 Pole	3
54718	Ebs, 7 Pole, Screw	3
54719	Abs, 15 Pole	4

Ball Joint



Auger No.	Dimensions
93858	M5x0,8/ø8/22 RHT
93859	M5x0,8/ø8/22 LHT
93860	M6x1/ø10/25 RHT
93861	M6x1/ø10/25 LHT
93862	M6x1/ø10/40 RHT
93863	M8x1,25/ø13/30 RHT
93864	M8x1,25/ø13/30 LHT
93865	M8x1,25/ø13/45 RHT
93866	M10x1,5/ø16/35 RHT
93867	M10x1,5/ø16/35 LHT
93868	M10x1,5/ø16/45 RHT
93869	M12x1,75/ø16/35 RHT
93870	M12x1,75/ø16/35 LHT

Flexible Hoses

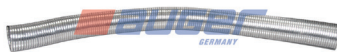

Type-1



Type-2

Auger No.	ID (mm)	L (mm)	Type	Auger No.	ID (mm)	L (mm)	Type
86552	51	1000	1	70186	108	1000	1
70177	61	1000	1	70185	111	1000	1
70175	70	1000	1	70184	115	1000	1
70174	77	1000	1	70183	121	1000	1
86553	81	1000	1	70181	128	1000	1
70179	83	1000	1	52524	80	295	2
70178	93	1000	1	52533	95	295	2
70176	95	1000	1	52525	105	295	2
70187	103	1000	1	52754	90	375	2

Cable Tie



Auger No.	Dimensions
102619	L: 360 mm
103012	L: 340 mm

Clamps



Auger No.	Min. D (mm)	Max. D (mm)	Auger No.	Min. D (mm)	Max. D (mm)
66487	8	13	66498	44	64
66488	10	16	66499	51	72
66489	13	19	66501	57	76
66490	16	23	66502	65	82
66491	18	25	66503	76	92
66492	20	30	66504	85	103
66493	22	36	66505	92	110
66494	25	42	66506	105	121
66495	28	48	66507	115	135
66496	32	51	66508	130	146
66497	38	58	66509	146	164



Auger No.	Min. D (mm)	Max. D (mm)	Auger No.	Min. D (mm)	Max. D (mm)
66510	54	62	66519	79	87
66511	57	65	66520	82	91
66512	60	68	66521	86	94
66513	63	72	66522	89	97
66514	67	75	66523	92	100
66515	70	78	66524	95	103
66516	73	81	66525	101	110
66517	76	84	66526	103	111
66518	78	86	66527	105	113

Blade, Windscreen Wiper



Type-1



Type-2

Auger No.	Properties	Dimensions (mm)	Type
79199	Without Nozzle, Hook Connection	450	1
79201	Without Nozzle, Hook Connection	550	1
79202	With Nozzle, Hook Connection, LHD	600	1
75209	Without Nozzle, Click-fit	600	1
79205	With Nozzle, Hook Connection	650	1
87577	Without Nozzle, Hook Connection	650	1
75207	Without Nozzle, Click-fit	650	1
90911	Without Nozzle, Hook Connection, With Hose Bracket	700	1
74892	Without Nozzle, Click-fit	700	1
79208	Without Nozzle, Screw Connection	700	1
79206	With Nozzle, Hook Connection, Banana Type	650	2
79207	Without Nozzle, Hook Connection, Banana Type	650	2

Filler Cap, Fuel Tank

	Auger No.	Properties	Dimensions (mm)	Type
Type-1	54696	Cr/Ni Coating, With Key	ø60	1
Type-2	54700	Cr/Ni Coating, With Key	ø80	1
Type-3	95391	Cr/Ni Coating, With Key	ø80	2
Type-4	95389	Plastic, With Key	ø80	3
Type-5	95397	Plastic, With Key	ø60	4
	95390	Plastic, With Key	ø80	4
	95396	Plastic, Without Key	ø60	5
	95392	Plastic, Without Key	ø80	5

Strainer, Fuel Tank

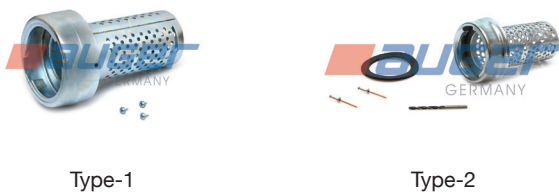

Auger No.	Dimensions (mm)	Type
56508	ø80 / 178	1
68434	ø60 / 157	1
95395	ø80	1
95398	ø80	1
68433	ø60 / 128,5	2

Tank Cap Preservation, Fuel Tank

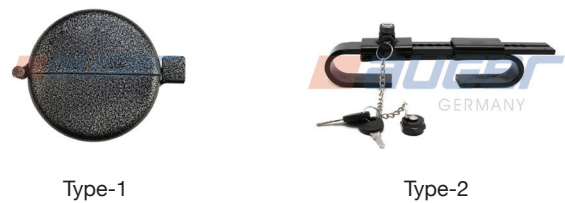

Auger No.	Type
95393	1
95394	2

Repair Kit, Fuel Tank



Auger No.	Type
91120	1
91121	2

Fuel Transfer Pump

Auger No.
Properties
Dimensions (mm)
81125

With Small Strainer, 24V, 25 L/Min

ø41x180

81126

With Big Strainer, 24V, 30-35 L/Min

ø50x205

95400

With Small Strainer, 12V

-

95403

With Big Strainer, 12V

-

95399

Without Small Strainer, 12V

-

95401

Without Small Strainer, 24V, 25 L/Min

-

95402

Without Big Strainer, 12V

-

95404

Without Big Strainer, 24V, 30-35 L/Min

-

81127

With Switch, Lux Type, 24V, 30-35 L/Min

145x170

95405

Without Switch, Lux Type, 24V, 30-35 L/Min

-

85505

Manual

8

85506

Manual

10

85507

Manual

12

Fuel Tank, Cab Heating & Ventilation



Auger No. **Properties**
78966 10 Lt



Auger No. **Properties**
79373 20 Lt



Auger No. **Properties**
92313 20 Lt



Auger No. **Properties**
92314 60 Lt



Auger No. **Properties**
92315 40 Lt

Repair Kit, SCR System



Auger No. **Properties**
68431 Adblue Tank

Tank Cap, SCR System



Type-1

Type-2

Type-3

Auger No.	Properties	Dimensions	Type
56506	Adblue Tank, With Key	M16x1,5/ø132x18	1
68429	Adblue Tank	ø96/ø90,5	2
68430	Adblue Tank	ø40	3

AdBlue, SCR System



Auger No.	Properties
104424	5 LT, DIN V 70070 ISO 22241-1
104425	10 LT, DIN V 70070 ISO 22241-1
104426	20 LT, DIN V 70070 ISO 22241-1
104427	30 LT, DIN V 70070 ISO 22241-1

Antifreeze, Radiator

Auger No.	Properties
104428	Organic-Blue, 1,5 LT, Antifreeze: %100, Water: %0, -56 °C
104430	Organic-Blue, 1,5 LT, Antifreeze: %100, Water: %0, -40 °C / -37 °C
104432	Organic-Blue, 1,5 LT, Antifreeze: %100, Water: %0, -25 °C
104434	Organic-Blue, 3 LT, Antifreeze: %100, Water: %0, -56 °C
104436	Organic-Blue, 3 LT, Antifreeze: %100, Water: %0, -40 °C / -37 °C
104438	Organic-Blue, 3 LT, Antifreeze: %100, Water: %0, -25 °C
104440	Organic-Blue, 5 LT, Antifreeze: %100, Water: %0, -56 °C
104442	Organic-Blue, 5 LT, Antifreeze: %100, Water: %0, -40 °C / -37 °C
104444	Organic-Blue, 5 LT, Antifreeze: %100, Water: %0, -25 °C
104446	Organic-Blue, 16 LT, Antifreeze: %100, Water: %0, -56 °C
104448	Organic-Blue, 16 LT, Antifreeze: %100, Water: %0, -40 °C / -37 °C
104450	Organic-Blue, 16 LT, Antifreeze: %100, Water: %0, -25 °C
104452	Organic-Yellow, 1,5 LT, Antifreeze: %100, Water: %0, -56 °C
104454	Organic-Yellow, 1,5 LT, Antifreeze: %100, Water: %0, -40 °C / -37 °C
104456	Organic-Yellow, 1,5 LT, Antifreeze: %100, Water: %0, -25 °C
104458	Organic-Yellow, 3 LT, Antifreeze: %100, Water: %0, -56 °C
104460	Organic-Yellow, 3 LT, Antifreeze: %100, Water: %0, -40 °C / -37 °C
104462	Organic-Yellow, 3 LT, Antifreeze: %100, Water: %0, -25 °C
104464	Organic-Yellow, 5 LT, Antifreeze: %100, Water: %0, -56 °C
104466	Organic-Yellow, 5 LT, Antifreeze: %100, Water: %0, -40 °C / -37 °C
104468	Organic-Yellow, 5 LT, Antifreeze: %100, Water: %0, -25 °C
104470	Organic-Yellow, 16 LT, Antifreeze: %100, Water: %0, -56 °C
104472	Organic-Yellow, 16 LT, Antifreeze: %100, Water: %0, -40 °C / -37 °C
104474	Organic-Yellow, 16 LT, Antifreeze: %100, Water: %0, -25 °C



Antifreeze, Radiator

Auger No.	Properties
104476	Inorganic-Green, 1,5 LT, Antifreeze: %100, Water: %0, -56 °C
104478	Inorganic-Green, 1,5 LT, Antifreeze: %100, Water: %0, -40 °C / -37 °C
104480	Inorganic-Green, 1,5 LT, Antifreeze: %100, Water: %0, -25 °C
104482	Inorganic-Green, 3 LT, Antifreeze: %100, Water: %0, -56 °C
104484	Inorganic-Green, 3 LT, Antifreeze: %100, Water: %0, -40 °C / -37 °C
104486	Inorganic-Green, 3 LT, Antifreeze: %100, Water: %0, -25 °C
104488	Inorganic-Green, 5 LT, Antifreeze: %100, Water: %0, -56 °C
104490	Inorganic-Green, 5 LT, Antifreeze: %100, Water: %0, -40 °C / -37 °C
104492	Inorganic-Green, 5 LT, Antifreeze: %100, Water: %0, -25 °C
104494	Inorganic-Green, 16 LT, Antifreeze: %100, Water: %0, -56 °C
104496	Inorganic-Green, 16 LT, Antifreeze: %100, Water: %0, -40 °C / -37 °C
104498	Inorganic-Green, 16 LT, Antifreeze: %100, Water: %0, -25 °C
104500	Inorganic-Blue , 1,5 LT, Antifreeze: %100, Water: %0, -56 °C
104502	Inorganic-Blue , 1,5 LT, Antifreeze: %100, Water: %0, -40 °C / -37 °C
104504	Inorganic-Blue , 1,5 LT, Antifreeze: %100, Water: %0, -25 °C
104506	Inorganic-Blue , 3 LT, Antifreeze: %100, Water: %0, -56 °C
104508	Inorganic-Blue , 3 LT, Antifreeze: %100, Water: %0, -40 °C / -37 °C
104510	Inorganic-Blue , 3 LT, Antifreeze: %100, Water: %0, -25 °C
104512	Inorganic-Blue , 5 LT, Antifreeze: %100, Water: %0, -56 °C
104514	Inorganic-Blue , 5 LT, Antifreeze: %100, Water: %0, -40 °C / -37 °C
104516	Inorganic-Blue , 5 LT, Antifreeze: %100, Water: %0, -25 °C
104518	Inorganic-Blue , 16 LT, Antifreeze: %100, Water: %0, -56 °C
104520	Inorganic-Blue , 16 LT, Antifreeze: %100, Water: %0, -40 °C / -37 °C
104522	Inorganic-Blue , 16 LT, Antifreeze: %100, Water: %0, -25 °C



Windshield Washer Fluid



Auger No.	Properties
104408	1 LT, Glass Water: %100, Water: %0, -60 °C
104410	1 LT, Glass Water: %100, Water: %0, -45 °C
104412	1 LT, Glass Water: %100, Water: %0, -22 °C
104414	1 LT, Glass Water: %100, Water: %0, -5 °C, Summery
104416	5 LT, Glass Water: %100, Water: %0, -60 °C
104418	5 LT, Glass Water: %100, Water: %0, -45 °C
104420	5 LT, Glass Water: %100, Water: %0, -22 °C
104422	5 LT, Glass Water: %100, Water: %0, -5 °C, Summery

Brake Fluid



Auger No.	Properties
104406	450 GR, SAE 1703 / FMVSS 116 DOT 4
104407	450 GR, SAE 1703 / FMVSS 116 DOT 3

Mudguard

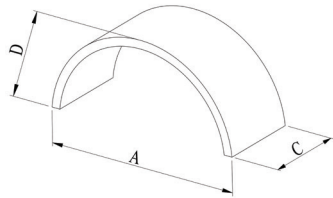

Type-1

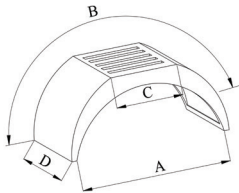

Type-2

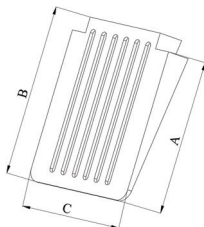

Type-3

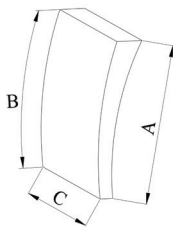

Type-4

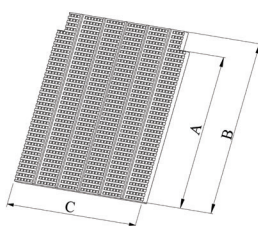

Type-5

Auger No.	A(mm)	B(mm)	C(mm)	D(mm)	Type
90933	1300	1960	450	450	1
90937	1335	2050	650	450	1
90938	1335	1900	650	450	1
90941	1100	1750	620	570	1
90943	1000	1600	530	500	1
90934	1300	1960	450	450	1
90935	1300	2125	450	450	1
90939	1335	1900	650	450	1
90940	1100	1750	620	570	1
90942	1000	1600	530	500	1
90944	930	1450	500	500	2
90945	850	1530	300	300	2
90936	810	900	450		3
90947	725	845	465		3
90946	725	735	440		4
90948	400	450			5

Bracket, Mudguard



Type-1

Type-2

Type-3

Auger No.	Properties	Type
90949	Long	1
90950	Short	1
90951	Steel	2
90952	Plastic	3
104643	Plastic	3

Wedge Clamp, Trailer Equipments



Type-1

Type-2

Auger No.	Properties	Type
84110	120, Painted	1
84108	160, Painted	1
84112	200, Painted	1
84111	120, Zinc	2
84109	160, Zinc	2
84113	200, Zinc	2

Wedge, Trailer Equipments

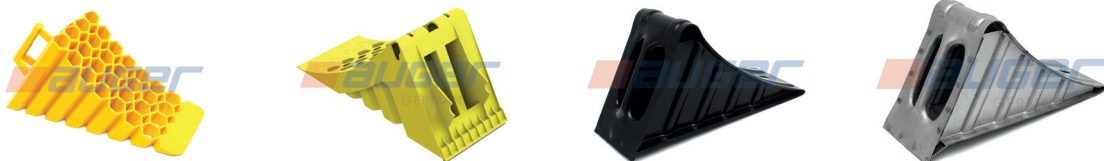

Type-1

Type-2

Type-3

Type-4

Auger No.	Properties	Dimensions (mm)	Type
84596		470x200x215 / R560	1
91300	With Sheet	493x197x225 / R560	2
91384	Without Sheet	493x197x225 / R560	2
107103	With Sheet	380x160x190 / R460	2
108632	Without Sheet	380x160x190 / R460	2
84104	120, DIN 76051, NG46 Painted		3
84102	160, DIN 76051, NG46 Painted		3
84106	200, DIN 76051, Painted		3
84105	120, DIN 76051, NG46 Zinc		4
84103	160, DIN 76051, NG46 Zinc		4
84107	200, DIN 76051, Zinc		4

Nut Indicator



Auger No.	Description	SW (mm)	Auger No.	Description	SW (mm)
91395	Yellow	19	91401	Yellow	30
91396	Yellow	21	91402	Yellow	32
91397	Yellow	22	83988	Yellow	33
91398	Yellow	24	91403	Yellow	38
91399	Yellow	27	91404	Yellow	41
91400	Yellow	28			



91405	Red	19	91411	Red	30
91406	Red	21	91412	Red	32
91407	Red	22	91413	Red	33
91408	Red	24	91414	Red	38
91409	Red	27	91415	Red	41
91410	Red	28			



91416	Yellow	17	91421	Yellow	27
91417	Yellow	19	91422	Yellow	30
91418	Yellow	21	91423	Yellow	32
91419	Yellow	22	91424	Yellow	33
91420	Yellow	24	91425	Yellow	38



91426	Red	17	91431	Red	27
91427	Red	19	91432	Red	30
91428	Red	21	91433	Red	32
91429	Red	22	91434	Red	33
91430	Red	24	91435	Red	38

Nut Indicator



Auger No.	Description	SW (mm)	Auger No.	Description	SW (mm)
91436	Black	32	91438	Silver Gray	32
91437	Black	33	91439	Silver Gray	33



91440	Yellow	17	91444	Yellow	27
91441	Yellow	19	91445	Yellow	30
83989	Yellow	21	91446	Yellow	32
91442	Yellow	22	83990	Yellow	33
91443	Yellow	24			



91447	Red	17	91452	Red	27
91448	Red	19	91453	Red	30
91449	Red	21	91454	Red	32
91450	Red	22	91455	Red	33
91451	Red	24			



83992	Black	32
--------------	-------	----

Nut Indicator



Auger No.	Description	SW (mm)	Auger No.	Description	SW (mm)
91456	Yellow	17	91465	Yellow	30
83994	Yellow	19	91466	Yellow	31
91457	Yellow	21	91467	Yellow	32
91458	Yellow	22	91469	Yellow	33
91459	Yellow	23	91470	Yellow	34
91460	Yellow	24	91471	Yellow	36
91461	Yellow	25	91472	Yellow	38
91462	Yellow	26	91473	Yellow	40
91463	Yellow	27	91474	Yellow	41
91464	Yellow	28	91475	Yellow	43



91476	Red	17	83993	Red	30
91477	Red	19	91486	Red	31
91478	Red	21	91487	Red	32
91479	Red	22	91489	Red	33
91480	Red	23	91490	Red	34
91481	Red	24	91491	Red	36
91482	Red	25	91492	Red	38
91483	Red	26	91493	Red	40
91484	Red	27	91494	Red	41
91485	Red	28	91495	Red	43



94514	Black	32
--------------	-------	----

Nut Indicator



Auger No.	Description	SW (mm)
91496	Yellow	24 6 Stud 205
91500	Yellow	24 6 Stud 245
91504	Yellow	27 6 Stud 205
91508	Yellow	27 6 Stud 245
91512	Yellow	30 10 Stud 335
91516	Yellow	30 8 Stud 275
91520	Yellow	32/33 10 Stud 335
91524	Yellow	32/33 8 Stud 275
91498	Red	24 6 Stud 205
91502	Red	24 6 Stud 245
91506	Red	27 6 Stud 205
91510	Red	27 6 Stud 245
91514	Red	30 10 Stud 335
91518	Red	30 8 Stud 275
91522	Red	32/33 10 Stud 335
91526	Red	32/33 8 Stud 275
91497	Silver Grey	24 6 Stud 205
91501	Silver Grey	24 6 Stud 245
91505	Silver Grey	27 6 Stud 205
91509	Silver Grey	27 6 Stud 245
91513	Silver Grey	30 10 Stud 335
91517	Silver Grey	30 8 Stud 275
91521	Silver Grey	32/33 10 Stud 335
91525	Silver Grey	32/33 8 Stud 275
91499	Black	24 6 Stud 205
91503	Black	24 6 Stud 245
91507	Black	27 6 Stud 205
91511	Black	27 6 Stud 245
91515	Black	30 10 Stud 335
91519	Black	30 8 Stud 275
91523	Black	32/33 10 Stud 335
91527	Black	32/33 8 Stud 275

Nut Indicator



Auger No.	Description	SW (mm)
91528	Yellow Twin	32
91530	Yellow Twin	33



Auger No.	Description	SW (mm)
91529	Red Twin	32
91531	Red Twin	33

Stud Cap



Type-1



Type-2



Type-3

Auger No.	Description	SW (mm)	Type
91532	Black, No Point	32	1
91533	Black, No Point	33	1
91534	Chrome, Long	32	2
91535	Chrome, Long	33	2
91536	Chrome, Standart	32	2
91537	Chrome, Standart	33	2
91540	Black, Standart	32	3
91541	Black, Standart	33	3
91538	Black, Long	32	3
91539	Black, Long	33	3

Screw Plug



Auger No. Dimensions

90338	M12x1,5 / SW17
90339	M14x1,5 / SW19
90340	M16x1,5 / SW22
90345	M22x1,5 / SW27

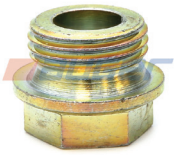

Auger No. Dimensions

90342	M18x1,5 / SW17
90343	M22x1,5 / SW19

Repair Kit, Spring

Auger No.

53049

Properties

Dimensions (mm): M20x1,5/ø26x142



Auger No.

53047

Properties

Dimensions (mm): M22x1,5/ø28x163,5



Auger No.

53048

Properties

Dimensions (mm): M24x1,5/ø30x164



Repair Kit, Spring

Auger No.

53046

Properties

Dimensions (mm): M24x1,5/ø30x190,5



Auger No.

53045

Properties

Dimensions (mm): M24x1,5/ø30x192



Lashing Strap, Trailer Equipments

Auger No.

52923

Properties

Dimensions (mm): 8 M



Auger No.

52924

Properties

Dimensions (mm): 10 M



Auger No.

52925

Properties

Dimensions (mm): 12 M



Buffer, Trailer Equipments**Auger No.****83911****Properties**

Dimensions (mm): 63,5x375x68,5

**Auger No.****83912****Properties**

Dimensions (mm): 123,5x163x75,5

**Auger No.****83913****Properties**

Dimensions (mm): 105x250x132,5

**Auger No.****83914****Properties**

Dimensions (mm): 126,5x167x63

**Auger No.****84738****Properties**

Dimensions (mm): 105x382x133

Edge Protection



Type-1



Type-2



Type-3

Auger No.

104640

104641

104642

Dimensions (mm)

110 / 58 x 136

110 / 58 x 136

Type

1

2

3

Buffer, Trailer Equipments

Auger No.

83915

Properties

Dimensions (mm): 25x307x57



Auger No.

83916

Properties

Dimensions (mm): 25x326x60



Auger No.

83917

Properties

Dimensions (mm): 25x55x1070



Auger No.

84739

Properties

Dimensions (mm): 25x56x983



Lightings & Reflector

Ⓔ

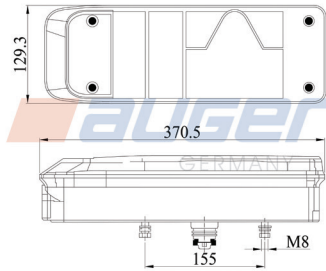

Auger No.

Properties

82783

Left, W-Socket, Without Bulb

82784

Right, W-Socket, Without Bulb

Functions

Reverse, Stop, Side Marker, Direction Indicator, Tail

Ⓔ

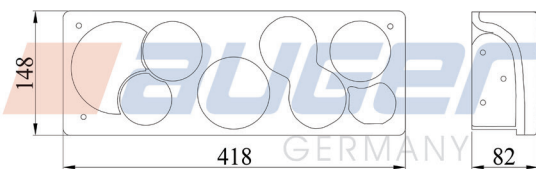

Auger No.

Properties

82785

Left, Without Bulb,
With License Plate Lamp

82786

Right, Without Bulb, With
Buzzer

Functions

Reverse, Stop, Side Marker, Direction Indicator, Rear Fog, Tail, Reflector

Ⓔ

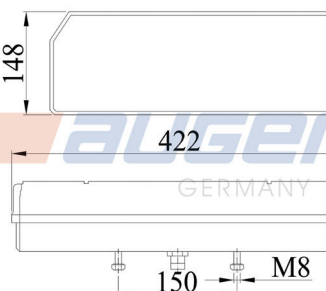

Auger No.

Properties

82781

Left, W-Socket, Without Bulb

82782

Right, W-Socket, Without Bulb

Functions

Reverse, Stop, Side Marker, Direction Indicator, Rear Fog, Tail

Lightings & Reflector

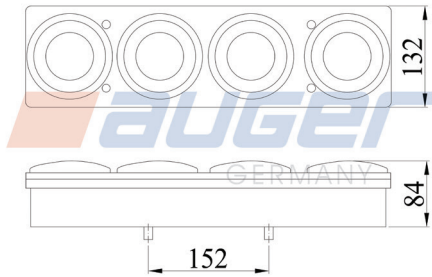

Auger No.

92311

Properties

Without Bulb

Functions

Reverse, Stop, Side Marker, Direction Indicator, Rear Fog, Reflector

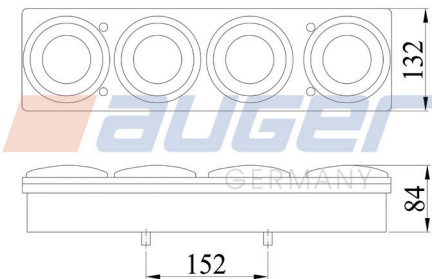

Auger No.

92312

Properties

Without Bulb

Functions

Reverse, Stop, Side Marker, Direction Indicator, Rear Fog, Reflector

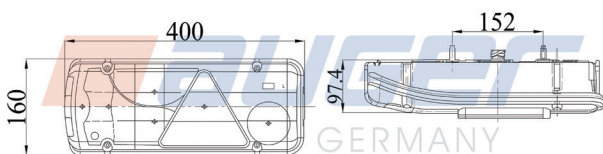

Auger No.

94025

Properties

Left

92842

Right

94028

Lens, Left

94029

Lens, Right

Functions

Indicator, Stop, Position, Reverse, Fog, Triangular reflector, End-outline marker lamp, Side position, Side reflector

Lightings & Reflector

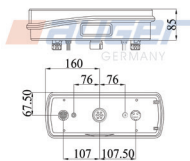
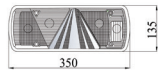

Auger No.

Properties

97899

Left, No Number Plate, Without Bulb

98970

Right

101430

Lens, Left

101431

Lens, Right

Functions

with indicator, with stop light, with rear fog light, with taillight, with reverse light, with reflex reflector (triangular), without number plate light

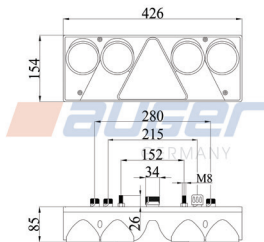

Auger No.

Properties

97917

Right, Without Bulb

99239

Left, Without Bulb

Functions

with indicator, with stop light, with rear fog light, with taillight, with reverse light, with reflector, without side marker light, without number plate light



Auger No.

Properties

101432

Only Lens

101433

Only Lens

Functions

Lightings & Reflector

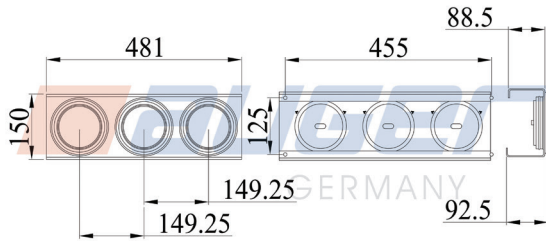

Auger No.

92291

Properties

Led

Functions

Direction Indicator, Tail, Stop, Reverse

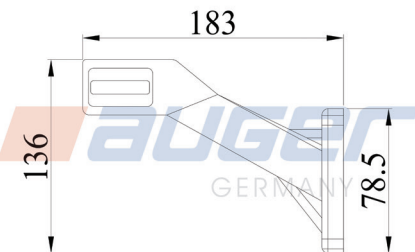

Auger No.

82797

Properties

4 W, Led, Left, Side

82798

4 W, Led, Right, Side

Functions

Marking Lamp

(E)

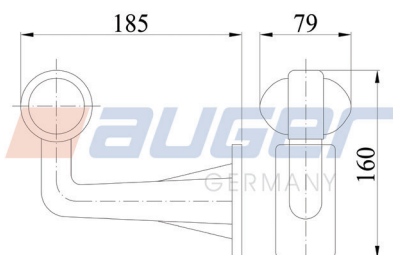

Auger No.

82801

Properties

5 W, Led, Left, Side

82802

5 W, Led, Right, Side

82803

Without Bulb, Side

Functions

Marking Lamp

Lightings & Reflector

(E)

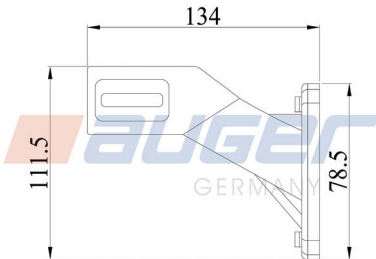

Auger No.

Properties

92263

Left, Led, Side

92264

Right, Led, Side

Functions

Marking Lamp

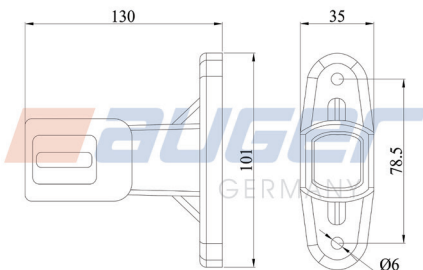

Auger No.

Properties

92265

Led, Side

Functions

Marking Lamp

(E)

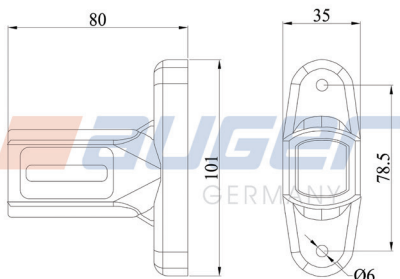

Auger No.

Properties

92266

Led, Side

Functions

Marking Lamp

Lightings & Reflector

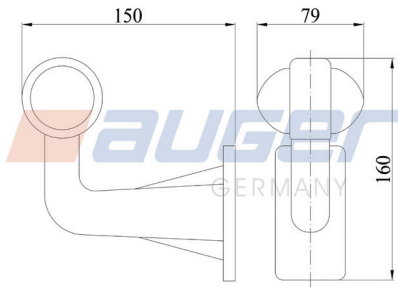

Auger No.

92267

Properties

Left, Led, Side

92268

Right, Led, Side

Functions

Marking Lamp

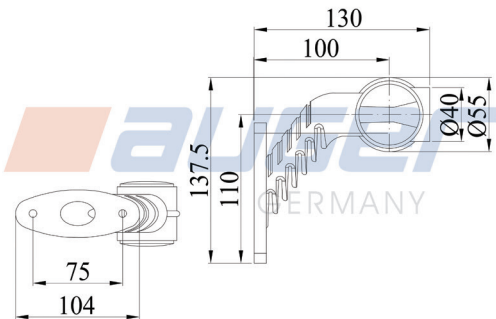

Auger No.

92303

Properties

Without Bulb, Side

Functions

Marking Lamp

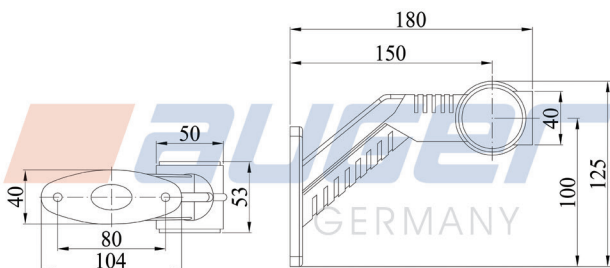

Auger No.

92304

Properties

Without Bulb, Side

Functions

Marking Lamp

Lightings & Reflector

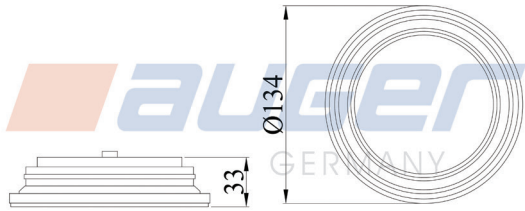

Auger No.	Properties	Functions
92292	Led, Red	Brake Lamp
92293	Led, Orange	Signal Lamp
92294	Led, White	Reverse Lamp
92295	Led, Red	Fog Lamp

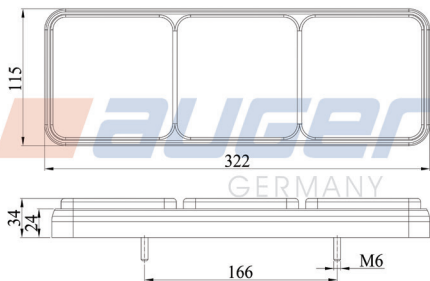
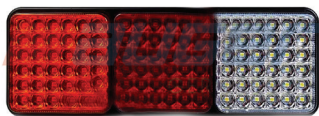

Auger No.	Properties
92296	Led

Functions
Direction Indicator, Tail, Stop, Reverse

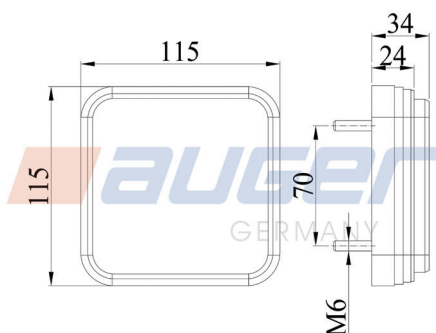

Auger No.	Properties	Functions
82787	Red, Left/Right, 24V, Square Led	Stop Light
82788	Orange, Left/Right, 24V, Square Led	Signal Lamp
82789	White, Left/Right, 24V, Square Led	Reverse Lamp

Lightings & Reflector

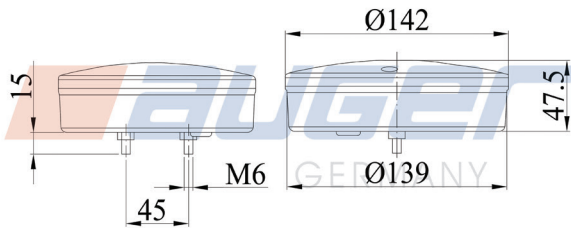

Auger No.

92287

Properties

Led

Functions

Direction Indicator,
Tail, Stop

92288

Led

Direction Indicator,
Tail, Stop, Reverse

92289

Led, White

Reverse Lamp

92290

Led, Red

Fog Lamp

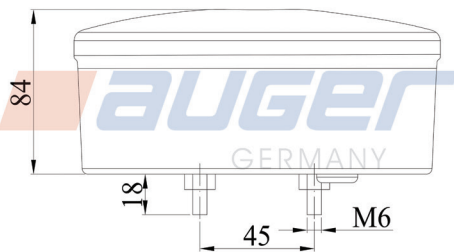

Auger No.

92305

Properties

Led

Functions

Direction Indicator,
Tail, Stop

92308

Led

Direction Indicator,
Tail, Stop, Reverse

92306

Led, Red

Fog Lamp

92307

Led, White

Reverse Lamp

92309

Led, Orange

Signal Lamp



Auger No.

92310

Properties

Chrome

Functions

Frame, Stop Light

Lightings & Reflector

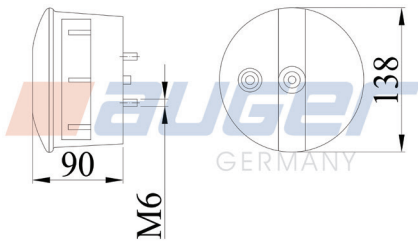

Auger No.

85714

Properties

Left,
Without Bulb

Functions

Direction Indicator,
Tail, Stop, Number Plate

85715

Right,
Without Bulb

Direction Indicator,
Tail, Stop

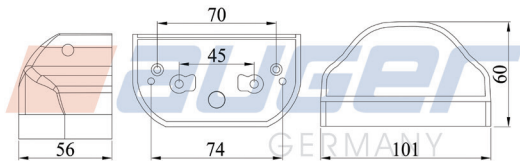

Auger No.

82804

Properties

5 W, Led, Side

Functions

Marking Lamp

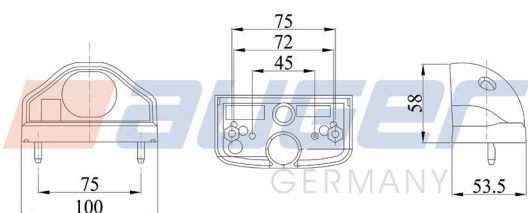

Auger No.

92849

Properties

24V, Led

Functions

License plate lamp

Lightings & Reflector

E

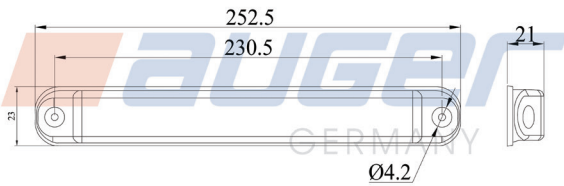

Auger No.

92269

Properties

Led, Yellow, Side

92270

Led, Red, Side

92271

Led, White, Side

92272

Led, Red, Side

Functions

Marking Lamp

E

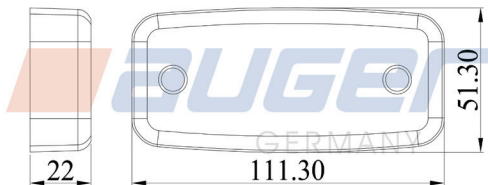
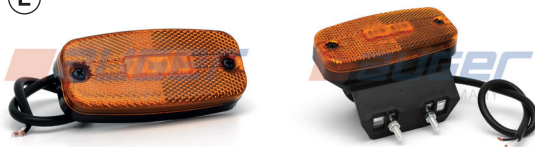

Auger No.

82790

Properties

24V, 3 Led, Side

82791

24V, 3 Led, With Bracket, Side

Functions

Marking Lamp



Auger No.

92297

Properties

Amber, Led, Without Bracket, Side

92298

Amber, Led, With Bracket, Side

Functions

Marking Lamp

Lightings & Reflector

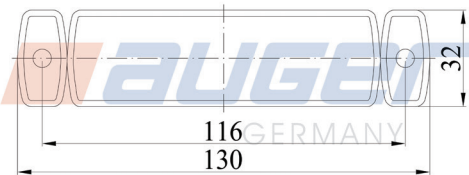

Auger No.

92300

Properties

Red, Led, Without Bracket, Side

92299

Red, Led, With Bracket, Side

Functions

Marking Lamp

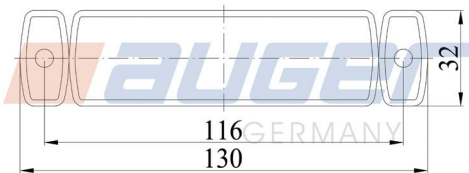

Auger No.

92302

Properties

White, Led, Without Bracket, Side

92301

White, Led, With Bracket, Side

Functions

Marking Lamp

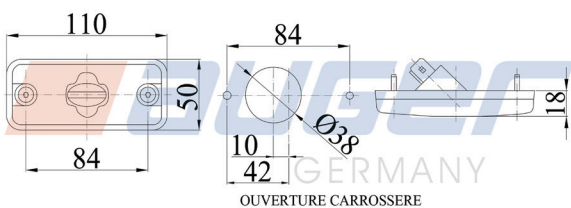

Auger No.

99022

Properties

End-Outline

Functions

Side position

Lightings & Reflector



Auger No.

Properties

82793

Led, 5x3W

82794

Led, 9x3W

96070

Led, 32V

105616

Led, 32V

Functions

Working Lamp



Auger No.

Properties

82792

24V, Without Bulb

Functions

Working Lamp

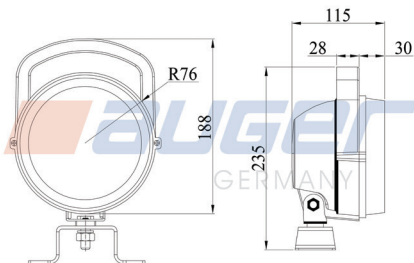

Auger No.

Properties

96068

Led, 32V

Functions

Working Lamp



Lightings & Reflector

Ⓔ



Auger No.

82796

Properties

24V, Magnet, Without Bulb

99691

24V, Screw, Without Bulb

99692

12V, Magnet, Without Bulb

99693

12V, Screw, Without Bulb

Functions

Rotating Lamp



Auger No.

99009

Properties

2 Pin, LED, Amber

99010

2 Pin, LED, Blue

Functions

Rotating Lamp

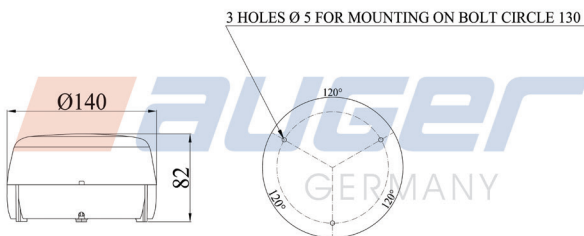

Auger No.

99038

Properties

LED, Amber

Functions

Rotating Lamp

Lightings & Reflector

Ⓔ

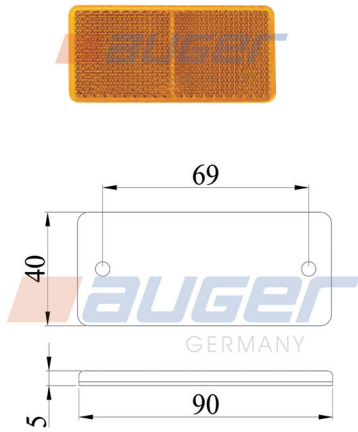

Auger No.

92273

Properties

White

92274

Amber

Functions

Reflector

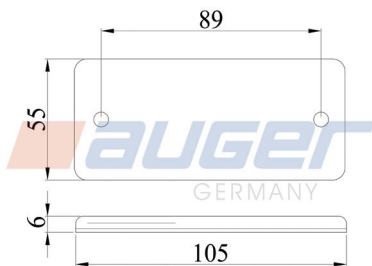

Auger No.

92278

Properties

White

92279

Amber

92280

Red

Functions

Reflector

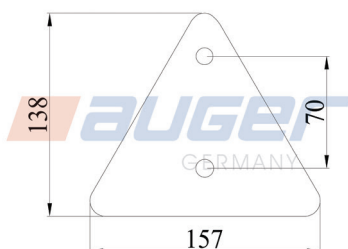
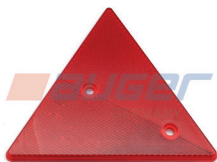

Auger No.

82805

Properties

For Trailer

Functions

Reflector

Lightings & Reflector

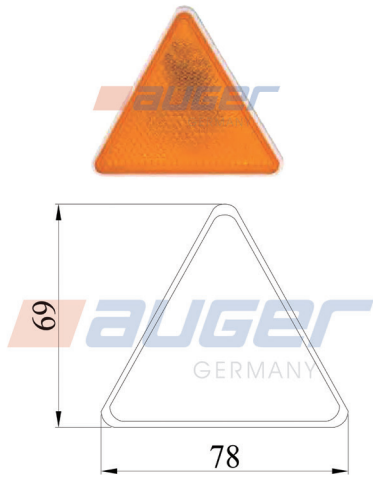

Auger No. Properties

92281	White
92282	Amber
92283	Red

Functions

Reflector

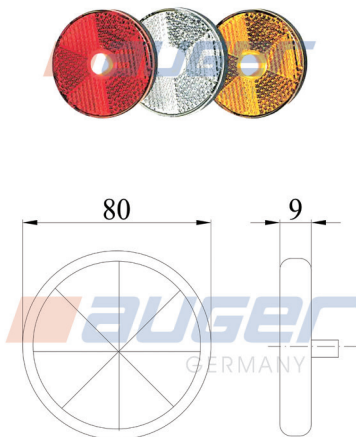

Auger No. Properties

92275	White
92276	Amber
92277	Red

Functions

Reflector

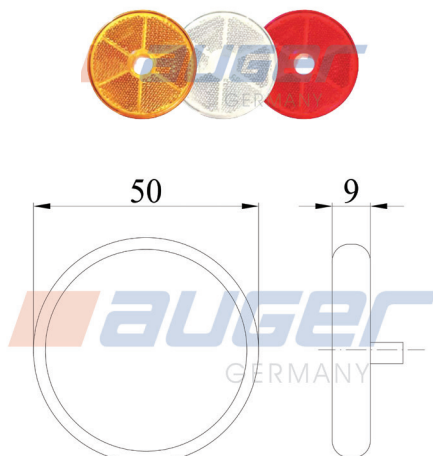

Auger No. Properties

92284	White
92285	Amber
92286	Red

Functions

Reflector

Lightings & Reflector

Ⓔ



Auger No.

82806

Properties

Footed, For Trailer

Functions

Reflector

Ⓔ



Auger No.

82807

Properties

Aluminium, For Trailer

Dimensions (mm)

565x200

Ⓔ



Auger No.

82808

Properties

Aluminium, For Trailer

Dimensions (mm)

560x135

Bulbs

Auger No.	Bulb Type	Lamp Shape	Rated Power (W)	Socket Type	Voltage	Parameter	Lenght
91334	H1	H1	55	P14,5s	12	-	-



Auger No.	Bulb Type	Lamp Shape	Rated Power (W)	Socket Type	Voltage	Parameter	Lenght
98504	H1	H1	70	P14,5s	24	HD	-



Auger No.	Bulb Type	Lamp Shape	Rated Power (W)	Socket Type	Voltage	Parameter	Lenght
91335	H3	H3	55	PK22s	12	-	-



Auger No.	Bulb Type	Lamp Shape	Rated Power (W)	Socket Type	Voltage	Parameter	Lenght
98505	H3	H3	70	PK22s	24	HD	-



Auger No.	Bulb Type	Lamp Shape	Rated Power (W)	Socket Type	Voltage	Parameter	Lenght
102733	H3	H3	70	PK222	24	-	-



Auger No.	Bulb Type	Lamp Shape	Rated Power (W)	Socket Type	Voltage	Parameter	Lenght
91336	H4	H4	60/55	P43	12	-	-

Bulbs



Auger No.	Bulb Type	Lamp Shape	Rated Power (W)	Socket Type	Voltage	Parameter	Lenght
91337	H4	H4	75/70	P43t	24	HD	-



Auger No.	Bulb Type	Lamp Shape	Rated Power (W)	Socket Type	Voltage	Parameter	Lenght
98506	H4	H4	75/70	P43t	24	HD	-



Auger No.	Bulb Type	Lamp Shape	Rated Power (W)	Socket Type	Voltage	Parameter	Lenght
91338	H7	H7	70	PX26d	24	-	-



Auger No.	Bulb Type	Lamp Shape	Rated Power (W)	Socket Type	Voltage	Parameter	Lenght
91339	H7	H7 LL	55	PX26d	12	-	-



Auger No.	Bulb Type	Lamp Shape	Rated Power (W)	Socket Type	Voltage	Parameter	Lenght
91340	H7	H7	55	PX26d	12	-	-



Auger No.	Bulb Type	Lamp Shape	Rated Power (W)	Socket Type	Voltage	Parameter	Lenght
91341	H9	H9	65	PGJ19-5	12	-	-

Bulbs



Auger No.	Bulb Type	Lamp Shape	Rated Power (W)	Socket Type	Voltage	Parameter	Lenght
91342	H11	H11	55	PGJ19-2	12	-	-



Auger No.	Bulb Type	Lamp Shape	Rated Power (W)	Socket Type	Voltage	Parameter	Lenght
91344	HB4	HB4	51	P22d	12	-	-



Auger No.	Bulb Type	Lamp Shape	Rated Power (W)	Socket Type	Voltage	Parameter	Lenght
91354	R2 (Bilux)	R2	55/50	P45t	24	-	-



Auger No.	Bulb Type	Lamp Shape	Rated Power (W)	Socket Type	Voltage	Parameter	Lenght
91348	P21W	P21W	21	BA15s	12	-	-



Auger No.	Bulb Type	Lamp Shape	Rated Power (W)	Socket Type	Voltage	Parameter	Lenght
91349	P21W	P21W	21	BA15s	24	-	-



Auger No.	Bulb Type	Lamp Shape	Rated Power (W)	Socket Type	Voltage	Parameter	Lenght
91351	P21/5W	P21/5W	21/5	BAY15d	12	-	-

Bulbs



Auger No.	Bulb Type	Lamp Shape	Rated Power (W)	Socket Type	Voltage	Parameter	Length
91352	P21/5W	P21/5W	21/5	BAY15d	24	-	-



Auger No.	Bulb Type	Lamp Shape	Rated Power (W)	Socket Type	Voltage	Parameter	Length
91355	R10W	R10W	10	BA15s	12	-	-



Auger No.	Bulb Type	Lamp Shape	Rated Power (W)	Socket Type	Voltage	Parameter	Length
91356	R5W	R5W	5	BA15s	12	-	-



Auger No.	Bulb Type	Lamp Shape	Rated Power (W)	Socket Type	Voltage	Parameter	Length
91357	R5W	R5W	5	BA15s	24	-	-



Auger No.	Bulb Type	Lamp Shape	Rated Power (W)	Socket Type	Voltage	Parameter	Length
91358	R5W	R5W	5	BA15d	24	-	-



Auger No.	Bulb Type	Lamp Shape	Rated Power (W)	Socket Type	Voltage	Parameter	Length
91359	R10W	R10W	10	BA15s	24	-	-

Bulbs



Auger No.	Bulb Type	Lamp Shape	Rated Power (W)	Socket Type	Voltage	Parameter	Lenght
91364	W21W	P21W	21	BA15s	24	HD	-



Auger No.	Bulb Type	Lamp Shape	Rated Power (W)	Socket Type	Voltage	Parameter	Lenght
91367	T4W	T4W	4	BA9s	12	-	-



Auger No.	Bulb Type	Lamp Shape	Rated Power (W)	Socket Type	Voltage	Parameter	Lenght
91368	T4W	T4W	4	BA9s	24	-	-



Auger No.	Bulb Type	Lamp Shape	Rated Power (W)	Socket Type	Voltage	Parameter	Lenght
91369	T4W	T4W	4	BA9s	24	HD	-



Auger No.	Bulb Type	Lamp Shape	Rated Power (W)	Socket Type	Voltage	Parameter	Lenght
91387	H	-	2	BA9s	12	-	-



Auger No.	Bulb Type	Lamp Shape	Rated Power (W)	Socket Type	Voltage	Parameter	Lenght
91388	H	-	2	BA9s	24	-	-

Bulbs



Auger No.	Bulb Type	Lamp Shape	Rated Power (W)	Socket Type	Voltage	Parameter	Lenght
91353	PY21W	PY21W	21	BAU15s	12	Amber	-



Auger No.	Bulb Type	Lamp Shape	Rated Power (W)	Socket Type	Voltage	Parameter	Lenght
91343	H21W	H21W	21	BAY9s	12	-	-



Auger No.	Bulb Type	Lamp Shape	Rated Power (W)	Socket Type	Voltage	Parameter	Lenght
91350	P21W	H21W	5	BAY9s	24	-	-



Auger No.	Bulb Type	Lamp Shape	Rated Power (W)	Socket Type	Voltage	Parameter	Lenght
91389	C10W	C10W	10	SV8,5-8	12	-	44



Auger No.	Bulb Type	Lamp Shape	Rated Power (W)	Socket Type	Voltage	Parameter	Lenght
91346	W5W	C5W	5	SV8,5-8	24	-	36



Auger No.	Bulb Type	Lamp Shape	Rated Power (W)	Socket Type	Voltage	Parameter	Lenght
91347	C5W	C5W	5	SV8,5-8	12	-	39

Bulbs

Auger No.	Bulb Type	Lamp Shape	Rated Power (W)	Socket Type	Voltage	Parameter	Lenght
91360	W5W	W5W	5	W2,1x9,5d	12	-	-



Auger No.	Bulb Type	Lamp Shape	Rated Power (W)	Socket Type	Voltage	Parameter	Lenght
91361	W3W	W3W	3	W2,1x9,5d	12	-	-



Auger No.	Bulb Type	Lamp Shape	Rated Power (W)	Socket Type	Voltage	Parameter	Lenght
91362	W3W	W3W	3	W2,1x9,5d	24	-	-



Auger No.	Bulb Type	Lamp Shape	Rated Power (W)	Socket Type	Voltage	Parameter	Lenght
91363	W16W	W16W	16	W2,1x9,5d	12	-	-



Auger No.	Bulb Type	Lamp Shape	Rated Power (W)	Socket Type	Voltage	Parameter	Lenght
91365	W21W	W21W	5	W2,1x9,5d	24	-	-



Auger No.	Bulb Type	Lamp Shape	Rated Power (W)	Socket Type	Voltage	Parameter	Lenght
91333	D2S	D2S	35	P32d-2	85	Xenon	-

Nylon Pipe - Black - PA12



Auger No.	Tube OD (mm)	Tube Thickness (mm)	Tube L (m)
87613	4	1	25
81280	6	1	25
81281	8	1	25
87625	9	1,5	25
81282	10	1	25
66182	10	1,25	25
87614	10	1,5	25
107164	10	2	25
95807	11	1,5	25
99485	12	1,25	25
81283	12	1,5	25
107163	12	2	25
87616	14	2	25
81284	15	1,5	25
81285	16	2	25
95875	18	2	25
87108	18	3	50
87106	25	6	50

Push in Connector

Material: Plastic



Auger No.	Tube OD (mm/inc)
65883	4
85495	5
65949	6
65950	8
65951	10
65952	12
65953	15
65954	16
89956	3/16"
89957	1/4"
89958	3/8"

Push in Connector (Two Diameter)

Material: Plastic



Auger No.	Tube OD 1 (mm)	Tube OD 2 (mm)
65955	6	4
65956	8	4
65957	8	6
65958	10	8
65959	12	8
65960	12	10
65961	16	14

T Union Push in Connector

Material: Plastic



Auger No.	Tube OD (mm)
65988	4
89959	5
65989	6
65990	8
65991	10
65992	12
89960	15
65993	16

T Union Push in Connector (Two Diameter)

Material: Plastic



Auger No.	Tube OD 1 (mm)	Tube OD 2 (mm)
65994	6	4
65995	8	4
65996	8	6
65997	10	6
65998	10	8
65999	12	8
66000	12	10

90° Push in Connector

Material: Plastic



Auger No.	Tube OD (mm)
65962	4
89961	5
65963	6
65964	8
65965	10
65966	12
89962	15
65967	16

90° Push in Connector (Two Diameter)

Material: Plastic



Auger No.	Tube OD 1 (mm)	Tube OD 2 (mm)
65968	6	4
65969	8	4
65970	8	6
65971	10	6
65972	10	8
65973	12	8
65974	12	10

Y Union Push in Connector

Material: Plastic



Auger No.	Tube OD (mm)
65975	4
65976	6
65977	8
65978	10
65979	12
65980	16

4-Way Cross Push in Connector

Material: Plastic



Auger No.	Tube OD (mm)
66001	4
66002	6
66003	8
66004	10
66005	12

Male Push in Connector



Auger No.	Tube OD (mm)	Male Thread (mm/inc)
66009	6	M10x1
66013	8	M14x1,5
66017	10	M16x1,5
66020	12	M16x1,5
90023	6	M10x1
90024	6	M12x1,5
90025	6	M16x1,5
90026	6	M22x1,5
90027	8	M10x1
90028	8	M12x1,5
90029	8	M16x1,5
90030	8	M22x1,5
90031	10	M12x1,5
90032	10	M16x1,5
90033	10	M22x1,5
90034	12	M16x1,5
90035	12	M22x1,5
90036	15	M22x1,5
90037	16	M16x1,5
90038	16	M22x1,5
89994	4	M8x1
89995	4	M8x1,25
89996	4	M10x1
89999	6	M12x1
89997	4	1/8"
89998	4	1/4"
90001	6	1/8"
90002	6	1/4"
90003	8	1/8"
90004	10	1/4"

Push in Connector



Auger No.	Tube OD (mm/inc)	Tube Thickness (mm)	Male Thread (mm)
66022	4	1	M10x1
66023	4	1	M12x1,5
66024	4	1	M22x1,5
66025	6	1	M10x1
90005	6	1	M12x1,5
66026	6	1	M14x1,5
66027	6	1	M16x1,5
66028	6	1	M22x1,5
66029	8	1	M10x1
90006	8	1	M12x1,5
90007	8	1	M14x1,5
66030	8	1	M16x1,5
66031	8	1	M22x1,5
90008	9	1,5	M16x1,5
90009	9	1,5	M22x1,5
90010	10	1,5	M12x1,5
90011	10	1,5	M16x1,5
90012	10	1,5	M22x1,5
90013	10	1,25	M16x1,5
90014	10	1,25	M22x1,5
66033	10	1	M10x1
66034	10	1	M12x1,5
66035	10	1	M14x1,5
66036	10	1	M16x1,5
66037	10	1	M22x1,5
90015	11	1,5	M16x1,5
90016	11	1,5	M22x1,5
66049	12	1,5	M12x1,5
66050	12	1,5	M14x1,5
90017	12	1,5	M16x1,5
66051	12	1,5	M22x1,5
66053	15	1,5	M16x1,5
66054	15	1,5	M22x1,5
90018	15	1,5	M26x1,5
66056	16	2	M16x1,5
66057	16	2	M22x1,5
90019	16	2	M26x1,5
90020	18	2	M16x1,5
90021	18	2	M22x1,5
90022	18	2	M26x1,5

Push in Connector



Auger No.	Tube OD (mm/inc)
66065	4
66066	6
66067	8
90039	9
66068	10
90040	11
66071	12
66072	15
66073	16



Auger No.	Tube OD (mm/inc)	Tube Thickness (mm)	Male Thread (mm)
93682	6	1	M10x1
93683	6	1	M12x1,5
93684	6	1	M14x1,5
93685	6	1	M16x1,5
93686	6	1	M22x1,5
93687	8	1	M10x1
93688	8	1	M12x1,5
93689	8	1	M14x1,5
93690	8	1	M16x1,5
93691	8	1	M22x1,5
93692	10	1	M12x1,5
93693	10	1	M14x1,5
93694	10	1	M16x1,5
93695	10	1	M22x1,5
93696	10	1,25	M12x1,5
93697	10	1,25	M16x1,5
93698	10	1,25	M22x1,5
93699	10	1,5	M12x1,5
93700	10	1,5	M16x1,5
93701	10	1,5	M22x1,5
93702	12	1,5	M12x1,5
93703	12	1,5	M16x1,5
93704	12	1,5	M22x1,5
93705	15	1,5	M16x1,5
93706	15	1,5	M22x1,5
93707	16	2	M16x1,5
93708	16	2	M22x1,5

Push in Connector



Auger No.	Tube OD (mm/inc)
90041	4
89964	5
85497	6
85498	8
85499	10
85500	12
85501	15
85502	16



Auger No.	Tube OD (mm/inc)
90044	4
90045	5
90046	6
90047	8
90048	9
90049	10
90050	11
90051	12
90053	15
90054	16
90056	3/8"
90057	1/2"
90055	1/4"
90058	5/8"

Push in Connector with Internal Thread



Auger No.	Tube OD (mm)	Female Thread (mm)
89979	4	M8x1
89980	6	M8x1
66062	6	M12x1,5
65047	8	M14x1,5
66063	10	M16x1,5
66064	12	M22x1,5



Auger No.	Tube OD (mm)	Female Thread (mm)
90052	14	

Pipe Coupling

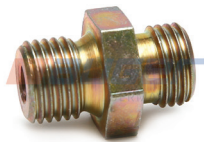

Auger No.	Tube OD (mm)	Male Thread 1 (mm/inc)	Male Thread 2 (mm)
90230	6	M10x1	M12x1,5
90231	8	M12x1,5	M14x1,5
90232	8	M14x1,5	M14x1,5
90233	10	M12x1,5	M16x1,5
90235	12	M12x1,5	M18x1,5
90236	12	M16x1,5	M18x1,5
90237	12	M18x1,5	M22x1,5
90238	12	M16x1,5	M18x1,5
90234	10	R 1/4"	M16x1,5
90239	15	M16x1,5	M22x1,5
90240	15	M18x1,5	M22x1,5
90241	15	R 1/2"	M22x1,5
90242	6	M12x1,5	M12x1,5
90243	8	M14x1,5	M14x1,5
90244	10	M16x1,5	M16x1,5
90245	12	M18x1,5	M18x1,5
90246	15	M22x1,5	M22x1,5
90247	16	M22x1,5	M22x1,5
90248	18	M26x1,5	M26x1,5
90249	6 - 8	M12x1,5	M14x1,5
90250	6 - 10	M12x1,5	M16x1,5
90251	6 - 15	M12x1,5	M22x1,5
90252	8 - 15	M14x1,5	M22x1,5
90253	10 - 15	M16x1,5	M22x1,5
90254	12 - 15	M18x1,5	M22x1,5
90257	15 - 18	M22x1,5	M26x1,5
90255	15	M22x1,5	M22x1,5
90256	18	M26x1,5	M26x1,5
90258	10	M16x1,5	M16x1,5
90259	10	M16x1,5	M16x1,5
90260	12	M18x1,5	M18x1,5
90261	15	M22x1,5	M22x1,5
90262	12 - 15	M18x1,5	M22x1,5
93783	M22x1,5	M16x1,5	M22x1,5 - L: 40
93784	M22x1,5	M16x1,5	M16x1,5 - L: 40
93785	M22x1,5	M16x1,5	M16x1,5 - L: 24
93786	M22x1,5	M16x1,5	M22x1,5 - L: 24
66137	M22x1,5	M22x1,5	M16x1,5
66138	M22x1,5	M16x1,5	M16x1,5
107307		M18x1,5	M16x1,5

Pipe Coupling

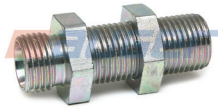

Auger No.	Tube OD (mm)	Male Thread 1 (mm/inc)	Male Thread 2 (mm)
90263	10	M16x1,5	M16x1,5
90264	12	M16x1,5	M18x1,5
90265	15	M16x1,5	M22x1,5
90268	16	M22x1,5	M22x1,5
90269	12 - 15	M18x1,5	M22x1,5
90271	15	R 1/2"	M22x1,5
90266	10 - 15	M16x1,5	M22x1,5
90267	12 - 15	M18x1,5	M22x1,5
93781	M22x1,5	M16x1,5	M22x1,5
93782	M22x1,5	M16x1,5	M16x1,5



90272		M16x1,5	M22x1,5
--------------	--	---------	---------



90282	6 - 15	M12x1,5	M22x1,5
--------------	--------	---------	---------



90283		M12x1,5	M22x1,5
--------------	--	---------	---------

Auger No.	Tube OD (mm)	Male Thread (mm)
90273	6 - 8	M12x1,5
90274	6 - 12	M12x1,5
90275	6 - 15	M12x1,5
90276	8 - 10	M14x1,5
90277	8 - 12	M14x1,5
90278	8 - 15	M14x1,5
90279	10 - 12	M16x1,5
90280	10 - 15	M16x1,5
90281	12 - 15	M18x1,5



Auger No.	Tube OD (mm)	Male Thread (mm)
93735	M10x1,5	P5
93736	M12x1,5	P5
93737	M14x1,5	P5
93738	M16x1,5	P5
93739	M22x1,5	P5
93740	M26x1,5	P5
93741	1/8" - 27NPTF	P5
93742	1/4" - 18NPTF	P5
93743	3/8" - 18NPTF	P5
93744	G1/4"	P5



Pipe Coupling



Auger No.	Tube OD (mm)	Male Thread (mm)
90285	15	M22x1,5 / L: 45,00
90286	15	M22x1,5 / L: 54,00



Auger No.	Tube OD (mm)	Male Thread (mm)
90287	15	M22x1,5



Auger No.	Tube OD (mm)	Male Thread (mm)
90288	15	M22x1,5



Auger No.	Tube OD (mm)	Male Thread (mm)
90289	15	M22x1,5



Auger No.	Tube OD (mm)	Male Thread (mm)
90290	6	M12x1,5
90291	12	M18x1,5
90292	12 - 15	M22x1,5
90299	6	M12x1,5
90297	8	M12x1,5 - M14x1,5
90298	8	M14x1,5 - M22x1,5
90300	10	M16x1,5 / L: 37,5
90301	10	M16x1,5 / L: 53,5
90302	10	M16x1,5 - M22x1,5
90303	12	M16x1,5 - M18x1,5
90304	12	M18x1,5 - M22x1,5
90305	12	M18x1,5
90293	15	M22x1,5
90296	15 - 18	M22x1,5 - M26x1,5

90° Elbow Bulkhead with Lock Nut and O-Ring



Auger No.	Thread 1 (mm)	Thread 2 (mm)
66086	M16x1,5	M12x1,5
66087	M16x1,5	M16x1,5
66088	M16x1,5	M22x1,5

T Union with Screwed Socket Plug-in



Auger No.	Thread 1 (mm)	Thread 2 (mm)
66093	M16x1,5	M12x1,5
66094	M16x1,5	M16x1,5
66095	M16x1,5	M22x1,5

Screwed Socket with Plug-in



Auger No.	Thread (mm)
66078	M22x1,5/SW28

90° Elbow Bulkhead with Male Thread



Auger No.	Tube OD (mm)	Thread (mm/inc)
89981	4	M6x1
89982	4	M8x1
89983	4	M8x1,25
89984	4	M10x1
89987	6	M6x1
89988	6	M8x1
89989	6	M10x1
89990	6	M12x1
89993	8	M12x1
89985	4	1/8"
89986	4	1/4"
89991	6	1/8"
89992	6	1/4"

90° Elbow Bulkhead with Male Thread



Auger No.	Tube OD (mm)	Thread (mm/inc)
93666	6x1	M12x1,5
93667	8x1	M12x1,5
93668	8x1	M22x1,5
93669	8x1	M16x1,5
93670	10x1	M12x1,5
93671	10x1	M16x1,5
93672	10x1	M22x1,5
93673	12x1,5	M22x1,5
93674	12x1,5	M16x1,5
93675	15x1,5	M22x1,5

Auger No.	Tube OD (mm)	Thread (mm/inc)
93725	6x1	P5
93726	8x1	P5
93727	10x1	P5
93728	10x1,25	P5
93729	10x1,5	P5
93730	12x1,5	P5
93731	15x1,5	P5
93732	15x2	P5
93733	16x2	P5

90° Elbow Coupling



Auger No.	Tube OD (mm)
90151	6
90152	8
90153	10
90154	12
90155	15
90156	15
90157	16
90158	18
90159	10 (M16x1,5)

Auger No.	Tube OD (mm)
90160	6
90161	8
90162	10
90163	12
90164	15

90° Elbow Coupling



Auger No.	Tube OD (mm)	Male Thread (mm)
90165	6	M10x1
90166	6	M12x1,5
90167	6	M16x1,5
90168	8	M12x1,5
90169	8	M14x1,5
90170	8	M16x1,5
90171	8	M22x1,5
90172	10	M12x1,5
90173	10	M14x1,5
90174	10	M16x1,5
90175	10	M22x1,5
90176	12	M16x1,5
90177	12	M22x1,5
90178	15	M16x1,5
90179	15	M22x1,5
90180	15	M22x1,5
90181	15	M22x1,5
90182	16	M22x1,5
90183	18	M22x1,5



Auger No.	Tube OD (mm)	Male Thread (mm)
90284	6	M12x1,5



Auger No.	Thread 1 (mm)	Thread 2 (mm)
93724	M16x1,5	P5



Auger No.	Thread (mm)
93745	12x1,5

90° Push in Connector



Auger No.	Tube OD (mm)
89971	4
89972	5
89973	6
89974	8
89975	10
89976	12
89977	15
89978	16

Auger No.	Tube OD (mm)
90059	4
90060	6
90061	8
90062	9
90063	10
90064	11
90065	12
90066	15
90067	16
90068	1/4"
90069	3/8"
90070	1/2"

T Union Push in Connector



Auger No.	Tube OD (mm/inc)
89965	4
89966	5
89967	6
87609	8
87630	10
89968	12
89969	15
89970	16

Auger No.	Tube OD (mm/inc)
90071	6
90072	8
90073	9
90074	10
90075	11
90076	12
90077	15
90078	16
90079	1/4"
90080	3/8"
90081	1/2"
90082	5/8"

T Union



Auger No.	Thread (mm)	Thread 1 (mm)	Thread 2 (mm)
90226	M16x1,5 / L: 42	M16x1,5 / L: 42	M16x1,5 / L: 48
90227	M18x1,5 / L: 42	M18x1,5 / L: 42	M16x1,5 / L: 48
90228	M22x1,5 / Ø 16	M22x1,5 / L: 84	M22x1,5 / L: 42
90221	M12x1,5		
90222	M14x1,5		
90223	M16x1,5		
90224	M18x1,5		
90225	M22x1,5		



Auger No.	Thread (mm)
90229	M22x1,5



Auger No.	Thread 1 (mm)	Thread 2 (mm)
66096	M12x1,5	M12x1,5
66097	M16x1,5	M16x1,5
66098	M22x1,5	M22x1,5



Auger No.	Thread 1 (mm)	Thread 2 (mm)
93720	M12x1,5	P5
93721	M16x1,5	P5



Auger No.	Thread 1 (mm)	Thread 2 (mm)
93722	M12x1,5	P5
93723	M16x1,5	P5

Hose Fitting

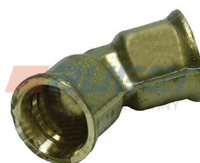

Auger No.	Thread 1 (mm)	Thread 2 (mm)
93734	M16x1,5	P5

Screw Plug with O-Ring



Auger No.	Dimensions
66133	M12x1,5/SW18
66134	M14x1,5/SW19
66135	M16x1,5/SW22
66136	M22x1,5/SW28

Lock Nut with O-Ring



Auger No.	Dimensions
66126	M12x1,5
66127	M16x1,5
66128	M22x1,5

Test Point



Auger No.	Dimensions
90346	M12x1,5 / SW17
90347	M12x1,5 / SW17
90348	M14x1,5 / SW17
90349	M16x1,5 / SW22
90350	M18x1,5 / SW24



90351	M22x1,5 / SW27
90368	M12x1,5 / SW17
90369	M14x1,5 / SW17



90352	M12x1,5 / SW17
90353	M14x1,5 / SW19



90354	M22x1,5 / SW27
66121	M16x1,5/M16x1,5
66122	M22x1,5/M16x1,5



90357	For Pipe Ø 8
90358	For Pipe Ø 10
90359	For Pipe Ø 12
90360	For Pipe Ø 15
90361	For Pipe Ø 12 Male Thread: M22x1,5



Auger No.	Dimensions
90362	For Hose Ø 13x6 Male Thread: M22x1,5



90364	For Pipe Ø 15 Male Thread: M22x1,5
-------	---------------------------------------



90365	M18x1,5 / SW24
-------	----------------



90367	For Pipe Ø 15 M22x1,5 / SW27
-------	---------------------------------



90371	M22x1,5
-------	---------



90372	For Pipe Ø 15 M22x1,5 / SW27
90373	For Pipe Ø 6 M16x1,5

Coupling Ring



Auger No.	Dimensions
90382	For Pipe Ø5x1 (DIN 74324) / ID: 12 / DIN 7642
90383	For Pipe Ø6x1 (DIN 74324) / ID: 12 / DIN 7642
90384	For Pipe Ø6x1 (DIN 74324) / ID: 14 / DIN 7642
90385	For Pipe Ø6x1 (DIN 74324) / ID: 16 / DIN 7642
90386	For Pipe Ø8x1 (DIN 74324) / ID: 16 / DIN 7642
90387	For Pipe Ø10x1 (DIN 74324) / ID: 12 / DIN 7642
90388	For Pipe Ø10x1 (DIN 74324) / ID: 14 / DIN 7642
90389	For Pipe Ø10x1 (DIN 74324) / ID: 16 / DIN 7642
90390	For Pipe Ø11x1,5 (DIN 74324) / ID: 22 / DIN 7642
90391	For Pipe Ø12x1,5 (DIN 74324) / ID: 16 / DIN 7642
90392	For Hose NW 4 / ID: 8
90393	For Hose NW 8 / ID: 14

Hose Nipple with O-Ring



Auger No.	Dimensions
66150	Tube ODxThickness: 6x1 / Thread: M14x1,5
66151	Tube ODxThickness: 6x1 / Thread: M16x1,5
66152	Tube ODxThickness: 6x1 / Thread: M22x1,5
66154	Tube ODxThickness: 8x1 / Thread: M12x1,5
66155	Tube ODxThickness: 8x1 / Thread: M14x1,5
66156	Tube ODxThickness: 8x1 / Thread: M16x1,5
66157	Tube ODxThickness: 8x1 / Thread: M22x1,5
66159	Tube ODxThickness: 10x1 / Thread: M14x1,5
66160	Tube ODxThickness: 10x1 / Thread: M16x1,5
66161	Tube ODxThickness: 10x1 / Thread: M22x1,5
66164	Tube ODxThickness: 10x1,5 / Thread: M16x1,5
66165	Tube ODxThickness: 10x1,5 / Thread: M22x1,5
66168	Tube ODxThickness: 12x1,5 / Thread: M16x1,5
66169	Tube ODxThickness: 12x1,5 / Thread: M22x1,5

Hose Nipple with O-Ring



Auger No.
93715

Dimensions

Tube OD: 11x3,5, Male Thread: M18x1,5



93716

Tube OD: 11x3,5, Male Thread: M16x1,5, L: 40

93717

Tube OD: 11x3,5, Male Thread: M22x1,5, L: 32

93718

Tube OD: 13x6, Male Thread: M16x1,5, L: 40

93719

Tube OD: 13x6, Male Thread: M22x1,5, L: 40



87607

Tube OD: 11, Male Thread: M16x1,5, L: 40

Union Nut - Brass



Auger No.

Tube OD (mm)

Thread (mm)

66194

6

M12x1,5

66195

10

M16x1,5

66196

12

M18x1,5

66197

15

M22x1,5

66198

16

M24x1,5

66199

18

M26x1,5

Union Nut - Steel



Auger No.

Tube OD (mm)

Thread (mm)

71325

6

M12x1,5

71326

10

M16x1,5

71327

12

M18x1,5

71328

15

M22x1,5

71329

16

M24x1,5

71330

18

M26x1,5

Union Nut

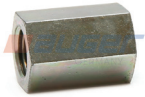

Auger No.	Female Thread (mm)	L (mm)
90313	M12x1,5	35
90314	M14x1,5	25
90315	M16x1,5	25
90316	M22x1,5	25
90317	M22x1,5	38
90318	M12x1,5 - M16x1,5	30
90319	M18x1,5 - M22x1,5	26
90320	R 1/2" - M22x1,5	35



93709	M12x1,5
93710	M16x1,5
93711	M22x1,5



90374	For Pipe Ø 6 / M12x1,5 / SW14
90375	For Pipe Ø 8 / M16x1,5 / SW19
90376	For Pipe Ø 10 / M16x1,5 / SW19
90377	For Pipe Ø 12 / M18x1,5 / SW22
90378	For Pipe Ø 15 / M22x1,5 / SW27
90379	For Pipe Ø 15 / M22x1,5 / SW27
90380	For Pipe Ø 15 / M22x1,5 / SW27 / L: 27
90381	For Pipe Ø 18 / M26x1,5 / SW32

Sleeve Insert for Nylon Pipe - Brass



Auger No.	Tube ID (mm)
89949	3
66200	4
89950	5
65062	6
89952	7
89953	7,5
66201	8
66202	9
89954	10
86610	11
66203	12x1,5
66204	12x2
66205	14

Sleeve Insert for Nylon Pipe - Steel



Auger No.	Tube ID (mm)
71305	4
71290	6
71306	8
71307	9
71308	12x1,5
71309	12x2
71310	14

Nylon Pipe Assembly Kit - Brass



Auger No.	Tube OD (mm)	Tube Thickness (mm)
66213	6	1
66214	8	1
66215	10	1
66216	12	1,5
66217	15	1,5
66218	16	2
66219	18	2

Nylon Pipe Assembly Kit - Steel

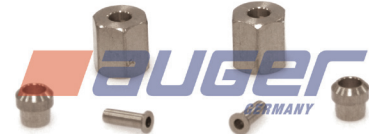

Auger No.	Tube OD (mm)	Tube Thickness (mm)
71318	6	1
71319	8	1
71320	10	1
71321	12	1,5
71322	15	1,5
71323	16	2
71324	18	2

Straight Coupling - Brass



Auger No.	Tube OD (mm)	Tube Thickness (mm)
66220	6	1
66221	8	1
66222	10	1
66223	12	1,5
66224	15	1,5
66225	16	2
66226	18	2

Straight Coupling - Steel



Auger No.	Tube OD 1 (mm)	Tube OD 2 (mm)
90083	4	
90084	5	
71311	6	1
90085	7	
71312	8	1
90086	9	
71313	10	1
90087	11	
71314	12	1,5
71315	15	1,5
71316	16	2
71317	18	2
90088	22	

Cutting Ring - Brass



Auger No.	Dimensions
66206	Tube OD: 6
66207	Tube OD: 8
66208	Tube OD: 10
66209	Tube OD: 12
66210	Tube OD: 15
66211	Tube OD: 16
66212	Tube OD: 18

Cutting Ring - Steel



Auger No.	Dimensions
71291	Tube OD: 6
65061	Tube OD: 8
71293	Tube OD: 10
71294	Tube OD: 12
71295	Tube OD: 15
71296	Tube OD: 16
71297	Tube OD: 18

Cutting Ring



Auger No.

Dimensions

90328

For Pipe Ø 10 / DIN 3867

90329

ID: 6 / OD: 9 / L: 8,5

90330

ID: 8 / OD: 11 / L: 9,5

90331

ID: 10 / OD: 13 / L: 10

90332

ID: 12 / OD: 15 / L: 10

90333

ID: 15 / OD: 18 / L: 10

90334

ID: 18 / OD: 21 / L: 10,5

90335

For Pipe Ø 1/4" / ID: 6,4 / OD: 8,6 / L: 6,2 / DIN 3861

90336

For Pipe Ø 1/2" / ID: 12,7 / OD: 15 / L: 9,5 / DIN 3861



Straight Coupling



Auger No.	Tube OD 1 (mm)	Tube OD 2 (mm)
90089	8	6
90090	10	6
90091	10	8
90092	12	6
90093	12	8
90094	12	10
90095	15	6
90096	15	8
90097	15	10
90099	18	15



Auger No.	Tube OD (mm)	Male Thread (mm/inc)
90100	6	M10x1
90101	6	M12x1,5
90102	6	M14x1,5
90103	6	M16x1,5
90104	6	M22x1,5
90105	8	M10x1
90106	8	M12x1,5
90107	8	M14x1,5
90108	8	M16x1,5
90109	8	M22x1,5
90110	10	M12x1,5
90111	10	M14x1,5
90112	10	M16x1,5
90113	10	M18x1,5
90114	10	M22x1,5
90115	12	M12x1,5
90116	12	M14x1,5
90117	12	M16x1,5
90118	12	M18x1,5
90119	12	M22x1,5
90120	15	M16x1,5
90122	15	M22x1,5
90123	15	M26x1,5
90124	16	M22x1,5
90125	6,00	R 1/8"

Straight Coupling



Auger No.	Tube OD (mm)	Male Thread (mm/inc)
90126	6,00	1/4" NPT
90127	8,00	1/4" - 1/8" NPT
90128	10,00	R 1/4"
90129	12,00	3/8" NPT
90130	12,00	1/2" NPT



Auger No.	Tube OD (mm)
90138	6
90139	8
90140	10
90141	12
90142	15
90143	16



Auger No.	Tube OD (mm)	Male Thread (mm/inc)
90144	8	M16x1,5
90145	10	M16x1,5
90146	10	M22x1,5
90147	12	M16x1,5
90148	12	M22x1,5
90149	15	M22x1,5
90150	16	M22x1,5



Auger No.	Tube OD (mm)	Male Thread (mm/inc)
90131	6	M22x1,5
90132	8	M22x1,5
90133	10	M22x1,5
90134	12	M16x1,5
90135	12	M22x1,5
90136	15	M22x1,5
90137	16	M22x1,5



Auger No.	Tube OD (mm)
93746	M10x1, S
93747	M10x1, R
93748	M12x1,5, S
93749	M12x1,5, R
93750	M14x1,5, S
93751	M14x1,5, R
93752	M16x1,5, S
93753	M16x1,5, R
93754	M16x1,5, HD
93755	M22x1,5, R
93756	M22x1,5, HD

Straight Coupling



Auger No.	Tube OD (mm)	Male Thread (mm/inc)
90306	M16x1,5	M10x1
90307	M18x1,5	M10x1
90308	M18x1,5	M12x1,5
90309	M22x1,5	M12x1,5
90310	M22x1,5	M14x1,5
90311	M22x1,5	M16x1,5
90312	M22x1,5	R 1/4"
93712	M16x1,5	M12x1,5
93713	M22x1,5	M12x1,5
93714	M22x1,5	M16x1,5



90321	M12x1,5	M22x1,5
90322	M14x1,5	M22x1,5
87608	M16x1,5	M22x1,5
90323	M22x1,5	M22x1,5
90324	R 3/8" / L: 32	M22x1,5
90325	R 3/8" / L: 26	M22x1,5
90327	M18x1,5	M18x1,5



93787	M16x1,5	8 / VOSS 232
-------	---------	--------------



93788	M16x1,5	8 / VOSS 232
93789	M18x1,5	12 / VOSS 232



97269	M18x1,5	
-------	---------	--

T Union Coupling



Auger No.	Tube OD 1 (mm)	Tube OD 2 (mm)
90192	6	8
90193	8	6
90194	10	6
90195	10	8
90196	12	6
90197	12	8
90198	12	10
90184	4	
90185	6	
90186	8	
87611	10	
90187	12	
90188	15	
90189	15	
90190	16	
90191	18	



Auger No.	Tube OD 1 (mm)	Tube OD 2 (mm)	Male Thread (mm)
90199	6	6	M12x1,5
90200	8	8	M12x1,5
90201	8	8	M16x1,5
90202	10	10	M16x1,5
90203	10	10	M22x1,5
90204	12	12	M16x1,5
90205	12	12	M22x1,5
90206	15	15	M22x1,5
90208	12	6	M16x1,5
90209	12	8	M16x1,5
90210	12	8	M22x1,5



Auger No.	Tube OD (mm)	Male Thread (mm)
90211	15	M22x1,5

T Union Coupling



Auger No.	Tube OD (mm)	Male Thread (mm)
93661	8x1	
93662	8x1 - 6x1	
93663	10x1	
93664	12x1,5	
93665	15x1,5	
93676	8x1	M16x1,5
93677	8x1	M22x1,5
93678	10x1	M22x1,5
93679	10x1	M16x1,5
93680	12x1,5 - 8x1	M22x1,5
93681	12x1,5	M16x1,5



87610	6	M12x1,5
90213	8	M14x1,5
90214	10	M16x1,5
90215	15	M22x1,5



90216	6,00	M12x1,5
90217	8,00	M14x1,5
90218	10,00	M16x1,5
90219	12,00	M18x1,5
90220	15,00	M22x1,5

Push in Connector



Auger No.	Dimensions
93757	Tube OD: 6x1, S
93758	Tube OD: 6x1, R
93759	Tube OD: 8x1, S
93760	Tube OD: 8x1, R
93761	Tube OD: 10x1, R
93762	Tube OD: 10x1,25, R
93763	Tube OD: 10x1,5, R
93764	Tube OD: 12x1,5, R
93765	Tube OD: 12x1,5, HD
93766	Tube OD: 15x1,5, HD
93767	Tube OD: 16x2, HD

Hollow Screw

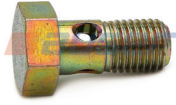

Auger No.	Dimensions
90394	M8x1 / SW12 / DIN 7643
90395	M10x1 / SW14 / DIN 7643
90396	M12x1,5 / SW17 / DIN 7643
90397	M14x1,5 / SW19 / DIN 7643
90398	M16x1,5 / SW22 / DIN 7643
90399	M18x1,5 / SW24 / DIN 7643
90400	M22x1,5 / SW27 / DIN 7643
90401	1/4" / SW19 / DIN 7643
90402	3/8" / SW22 / DIN 7643
90403	1/2" / SW27 / DIN 7643

Auger No.	Dimensions
90404	M8x1 / SW12 / DIN 7643
90405	M10x1 / SW14 / DIN 7643
90406	M14x1,5 / SW19 / DIN 7643
90407	M16x1,5 / SW22 / DIN 7643

90° Push in Connector



Auger No.	Dimensions
93768	Tube OD: 10x1,25, R
93769	Tube OD: 10x1,5, R
93770	Tube OD: 12x1,5, R
93771	Tube OD: 15x1,5, HD
93772	Tube OD: 16x2, HD

T Union



Auger No.	Dimensions
93773	L: 53, S
93774	L: 62, R
93775	L: 73, HD

90° Elbow

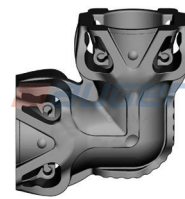

Auger No.

93776

93777

93778

Dimensions

Tube OD: 27, S

Tube OD: 31, R

Tube OD: 36, HD

Auger No.

93779

93780

Dimensions

L: 29, R

L: 34, HD

Washer and O-Ring Kit



Auger No.

90413

90414

90415

90416

90417

90418

Dimensions

For M10x1

For M12x1,5

For M14x1,5

For M16x1,5

For M18x1,5

For M22x1,5

Coupling Set

Auger No. Description

90408

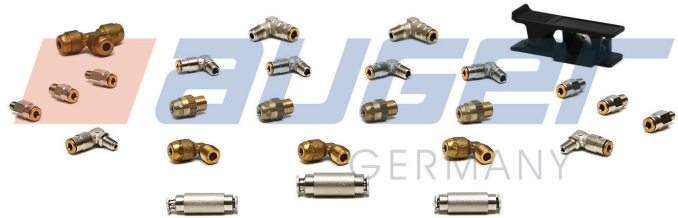

90409



90410

Voss 230

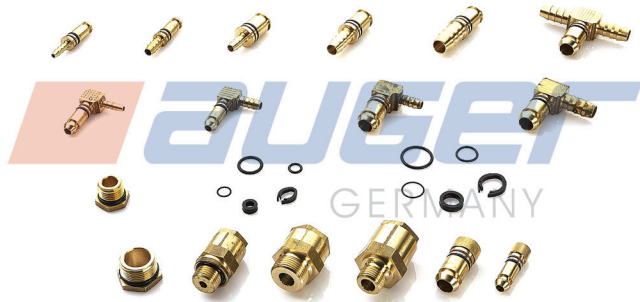

90412

Voss 240



iamauger.com



AUGER AUTOTECHNIK GmbH

🏠 Wankelstrasse 35, 50996, Köln

☎ +49 2236 871 88 0 📠 +49 2236 871 88 29